

becker marine systems



PRODUCTS



Manoeuvring
Systems



Energy-Saving
Devices



LNG Hybrid
Concepts



Mr. Henning Kuhlmann (left) and Mr. Dirk Lehmann, Managing Directors of Becker Marine Systems

	Manoeuvring Systems		Energy-Saving Devices		
	BECKER FLAP	BECKER TWIST	BECKER SCHILLING®	BECKER NOZZLE	BECKER MEWIS DUCT®
Profiles*	<ul style="list-style-type: none"> TL (Twisted Leading Edge) Closed Linkage (Heracles) 		<ul style="list-style-type: none"> TT (Twisted Trailing Edge) 	<ul style="list-style-type: none"> Steerable Fixed 	<ul style="list-style-type: none"> Twisted
Support	<ul style="list-style-type: none"> SA (Heel Pintle Rudder) SC (Full Spade Rudder) KSR (King Support Rudder) 	<ul style="list-style-type: none"> SA (Heel Pintle Rudder) SC (Full Spade Rudder) KSR (King Support Rudder) 	<ul style="list-style-type: none"> SA (Heel Pintle Rudder) SC (Full Spade Rudder) KSR (King Support Rudder) 	<ul style="list-style-type: none"> SA (Heel Pintle) SC (Full Spade Rudder) 	
Options	<ul style="list-style-type: none"> Bulb Carbon BIMS (Becker Intelligent Monitoring System) BBMS (Becker Bearing Monitoring System) 	<ul style="list-style-type: none"> Bulb BIMS (Becker Intelligent Monitoring System) BBMS (Becker Bearing Monitoring System) 	<ul style="list-style-type: none"> Bulb BIMS (Becker Intelligent Monitoring System) BBMS (Becker Bearing Monitoring System) 		

*Other rudder profiles like NACA are available on request

”DEAR READERS,

The international maritime industry faces big challenges. Greater efficiency, greater sustainability and increased safety are in demand on the world’s markets. As an innovative ship supplier, we would like to contribute towards meeting these goals with both our established products and ever new ideas.

In doing so, Becker Marine Systems benefits from nearly 70 years of experience. Over decades we have continuously improved our products and developed solutions for everyday ship operations. We view ourselves as a partner to our customers in order to offer customised solutions in the areas of manoeuvring, energy savings and emissions reduction. Our staff now consists of 230 highly qualified employees. And the various Becker products have been installed on over 8,000 vessels.

We equip vessels with highly manoeuvrable and efficient products such as the Becker Twist Rudder, including the largest container ships in the world. The successful Becker Mewis Duct® has increasingly been contributing to sustainable shipping. More than 1,000 of the energy-saving devices have already been sold, enabling a reduction of over 2.0 million tonnes of CO₂ on the world’s seas.

Furthermore, Becker is committed to the establishment of environmentally friendly liquefied natural gas (“LNG”) in the maritime industry. The LNG concept we developed for ship propulsion as well as the alternative shoreside supply of electricity to cruise ships by means of the LNG Hybrid Barge will in future be supplemented by a containerised concept for use on container ships, bulkers or tankers.”



PIONEERING IN MARINE TECHNOLOGY

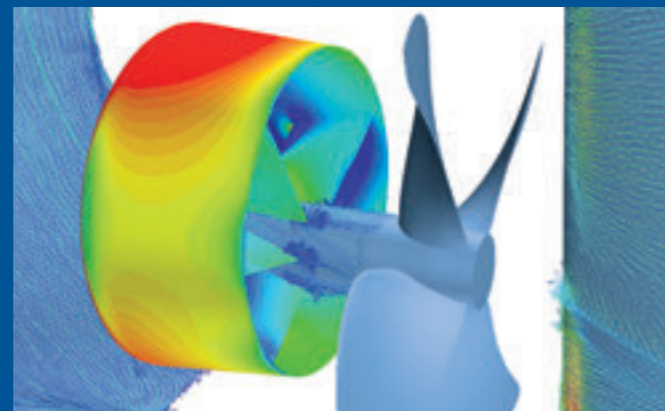
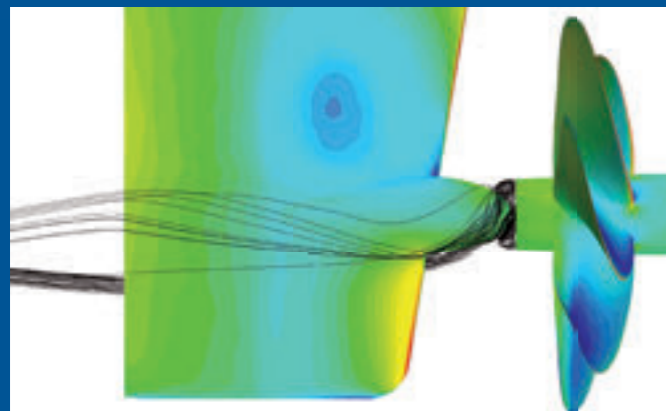

Founded by Willi Becker in 1946, Becker Marine Systems has developed into a company known worldwide for its innovative ship manoeuvring solutions as well as energy savings on the high seas and at port.

With the invention of the Becker Flap Rudder, market leadership for high performance rudders was already attained in the 1960s. As the technology leader, Becker is the standard for manoeuvring solutions. Spade rudders, twisted rudders, maintenance-free rudders and rudder bulb solutions have been developed by Becker. One important year was 2009, when the Becker Mewis Duct® was put on the market. The nozzle, which is mounted in front of the

ship's propeller in order to save energy, also developed into a successful product as did the Becker Mewis Duct® Twisted three years later with its special suitability for faster ships and container freighters.

The founding of a department for the utilisation of LNG in 2011 was of strategic significance. This enabled Becker's maritime expertise to focus more strongly on sustainability. Becker developed and operates the *Hummel* LNG Hybrid Barge, which works like a floating power plant and since 2015 has been supplying external and low-emission power to cruise ships at the Port of Hamburg.



ESPECIALLY SUITED FOR:

- Container feeders
- Shuttle tankers
- General cargo carriers/ heavy lifters
- Car carriers
- ConRo/RoRo
- Ferries
- Cruise liners
- OSV/PSV
- AHTS
- Push boats
- Research vessels
- Fishing vessels



ADVANTAGES:

- Optimised profile
- Reduced weight
- No cast parts
- Improved manoeuvrability
- Highest possible lift
- Flap angle up to 100°
- Crabbing
- Improved course keeping
- DP functionality
- Reduced tug assistance
- Best propeller coverage

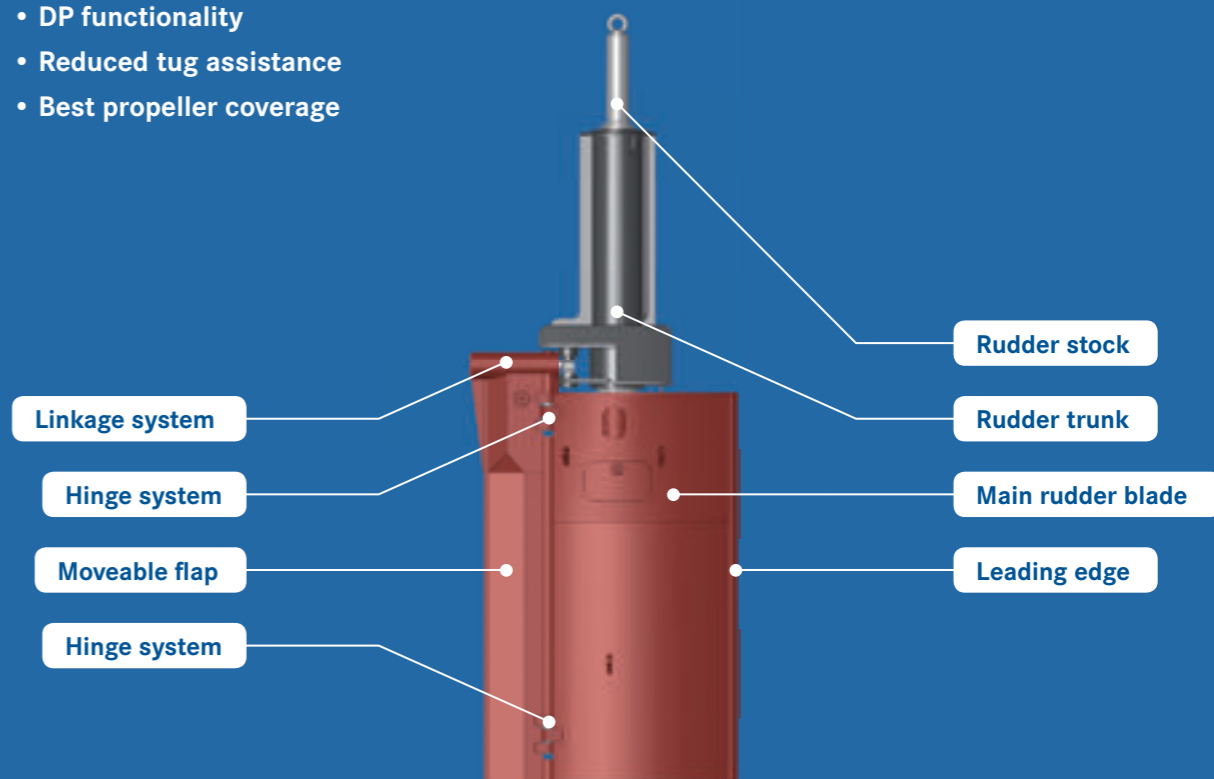

BECKER FLAP



The Becker Flap Rudder is the most popular rudder type worldwide and is derived from the first developments made by company founder Willi Becker. His invention is the ultimate rudder solution when it comes to ship manoeuvrability. With decades of research, development and practical experience behind it, this rudder is the most mature design of all flap rudders in the shipbuilding industry. Becker's unique design is now the standard for ship operators demanding manoeuvrability and efficiency. This high-performance rudder type offers an optimum balance and a flap area with the best combination of manoeuvrability and efficiency.

With a Becker Flap solution, captains are able to operate the vessel laterally. By using the Becker Flap, smaller ports or river operations in particular will generate a huge potential in terms of safety and efficiency. Over the years Becker has

developed a new design for the linkage and hinge system to reduce wear and tear and lower maintenance costs. The Becker Flap is suitable for refits and newbuildings wherever safety, manoeuvrability and efficiency play the leading role.

Several options are available for the basic rudder design, starting with a twisted profile for reduced risk of cavitation damage caused by the propeller slipstream, followed by a closed linkage system for enhanced safety in icy conditions and sandy environments.

In combination with Becker's King Support Rudder (KSR) bearing, the Becker Flap Rudder is unlimited in size. A Heel Pintle support is available for enhanced system stability (e.g. for fishing/offshore vessels).

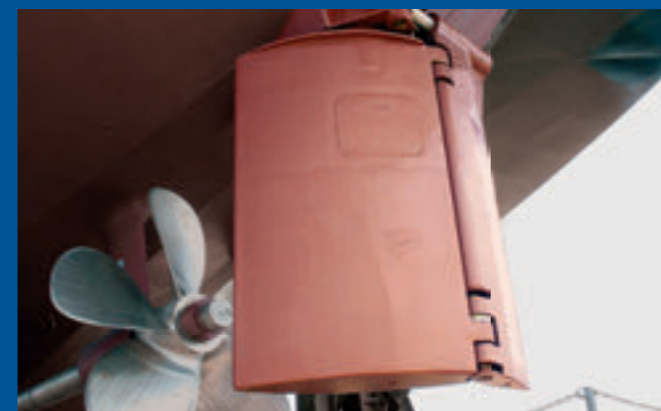



ESPECIALLY SUITED FOR:

- General cargo carriers/ Heavy lifters
- OSV/PSV
- AHTS
- Push boats
- Research vessels
- Fishing vessels
- Dredgers
- Yachts
- Navy ships

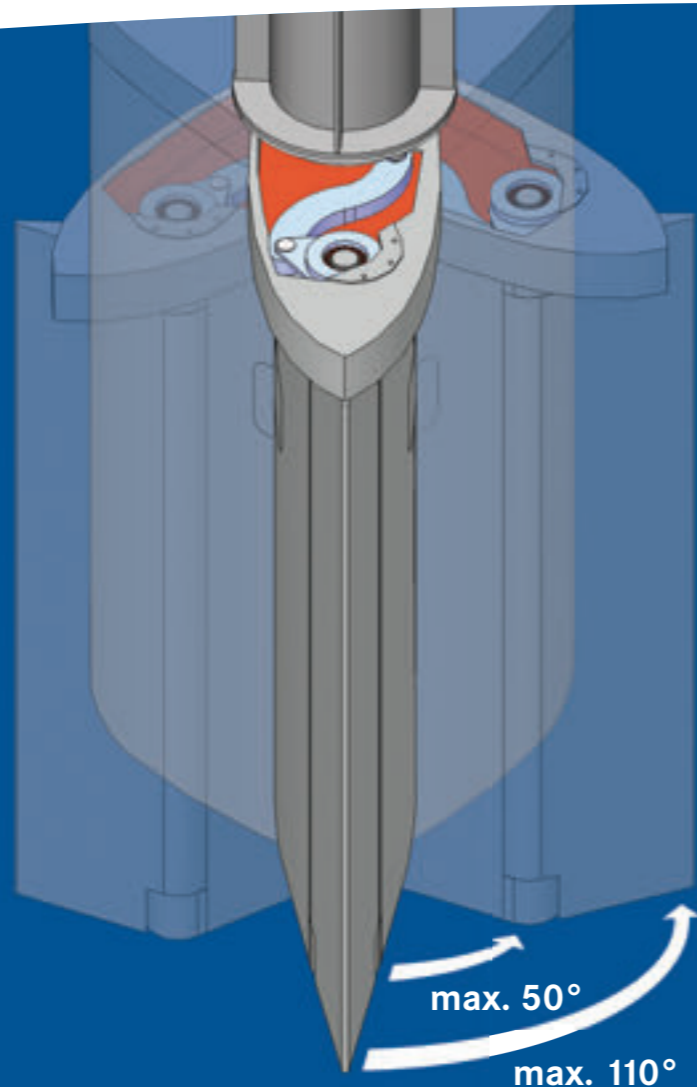

ADVANTAGES:

- Optimised profile
- Closed flap gear
- Protection against mud and sand
- Silent rudder operation
- Reduced weight
- No cast parts
- Improved manoeuvrability
- Highest possible lift
- Flap angle up to 100°
- Crabbing
- Improved course keeping
- DP functionality
- Reduced tug assistance
- Best propeller coverage

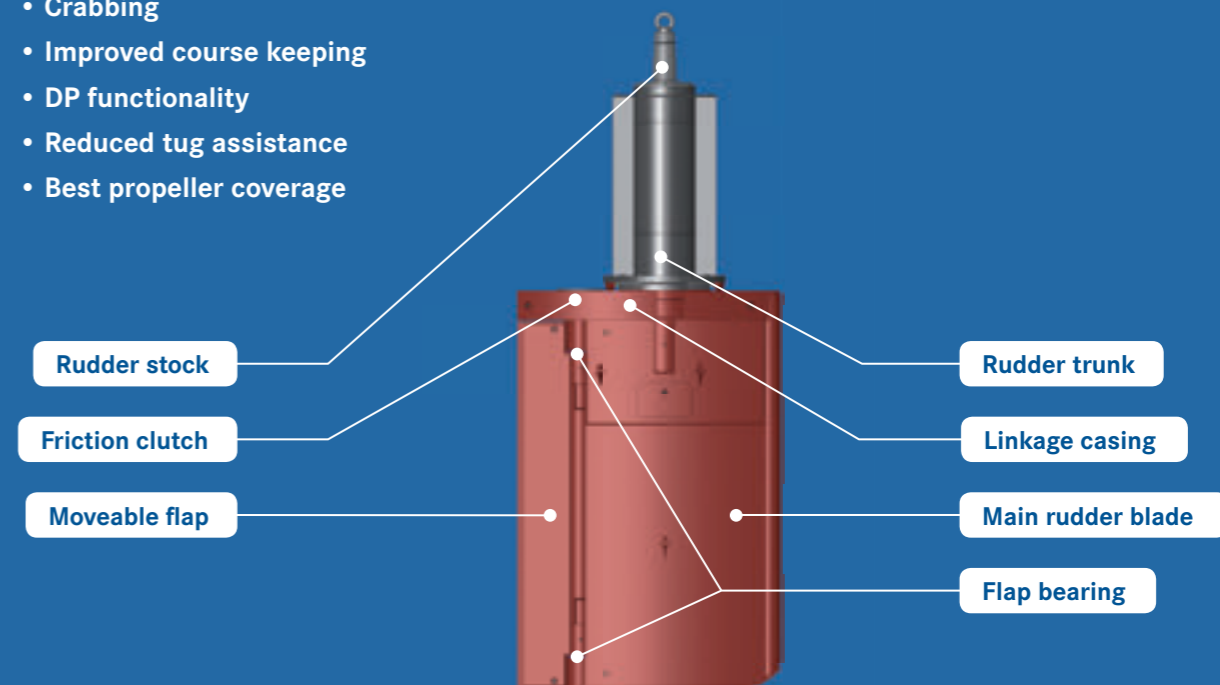

BECKER FLAP WITH CLOSED LINKAGE (HERACLES)

The Becker Flap Rudder with closed linkage system is the solution for the most difficult environmental conditions. Its sophisticated design incorporates the benefits of a flap mechanism, which is protected in a hydrodynamically-shaped top section of the rudder blade with a progressive flap angle ratio. This provides improved manoeuvrability at high rudder angles, smooth steering response, low resistance under steering and excellent course keeping. The closed flap linkage system is designed for high durability and protection against excessive forces. It also provides optimum protection of the linkage system from ice and sand.

Another advantage of the closed linkage system is noise reduction while steering. This allows rudder operation even while performing sensitive acoustic measurements.

Enhanced safety is achieved via an overload protection of the rudder flap, which prevents both the mechanism from being damaged as well as the rudder from being rendered inoperable due to flap blockages and obstruction. The integrated friction clutch protects the rudder flap against any damage from outside. In case the rudder flap becomes struck, the clutch will slip and give way to the overload. The flap will self-centre after the rudder is steered hard portside and starboard.





ESPECIALLY SUITED FOR:

- Container liners
- Tankers
- LNG/LPG carriers
- Car carriers
- ConRo/RoRo
- Ferries
- Yachts
- Navy ships



ADVANTAGES:

- Optimised profile
- Reduced weight
- No cast parts
- Less cavitation
- Reduction of rotational losses
- Improved propulsion efficiency
- Minimised drag
- Fuel saving
- Reduced wear and tear
- Best propeller coverage

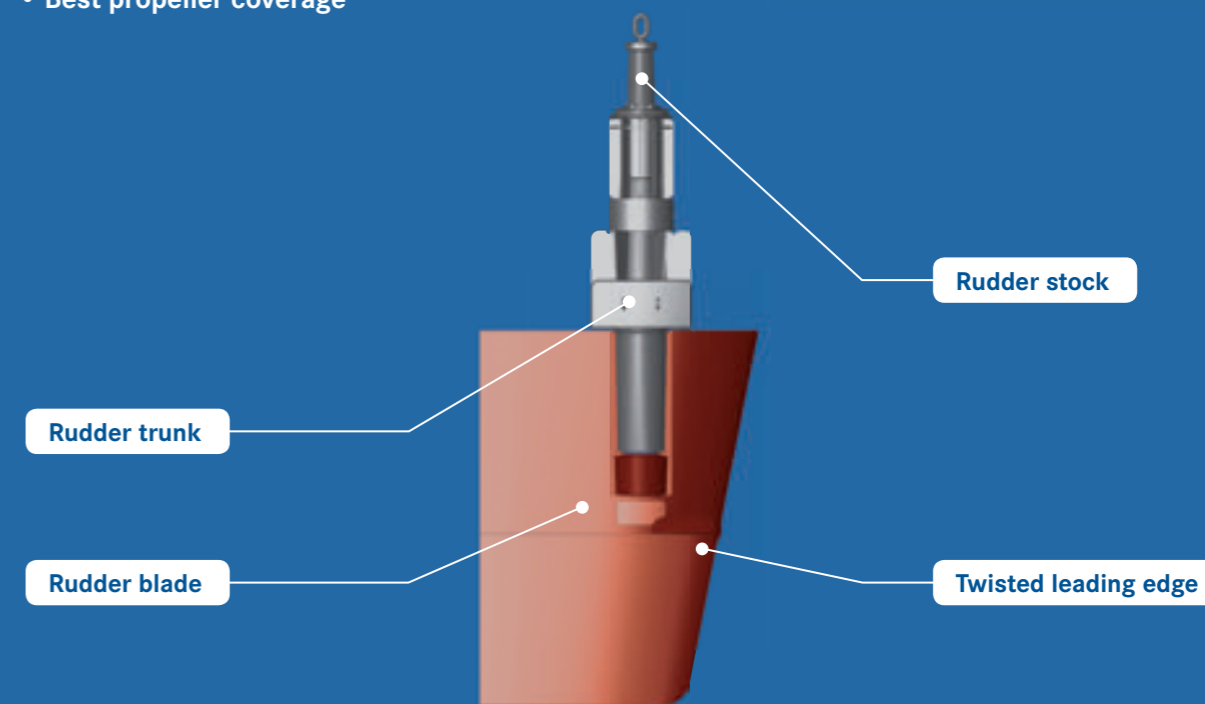
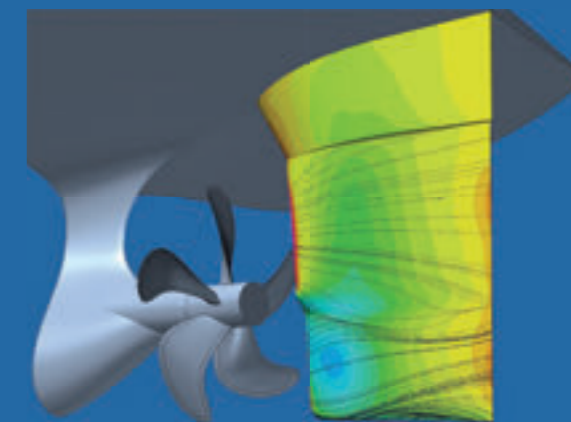

BECKER TWIST



The rudder is one of the most heavily strained components on a ship. Water flow with a higher velocity and a slight angle over a rudder blade will, under certain conditions, result in cavitation which will increase fuel consumption and cause erosion on the rudder's surface.

Conventional rudders are placed behind the propeller with the rudder cross section arranged symmetrically on the vertical rudder centre plane. However, this arrangement does not consider the fact that the propeller induces a strong rotational flow impinging on the rudder blade. This results in areas of low pressure on the blade, inducing cavitation.

The Becker Twist design equalises pressure distribution on the rudder blades. To avoid cavitation and to improve the manoeuvrability performance of a full spade rudder, Becker Marine Systems has enhanced the development of the Becker Twist Rudder. With the Becker Twist Rudder solution cavitation and gap cavitation are prevented, resulting in lower servicing and maintenance costs. In addition, the Becker Twist Rudder reduces noise caused by cavitation.

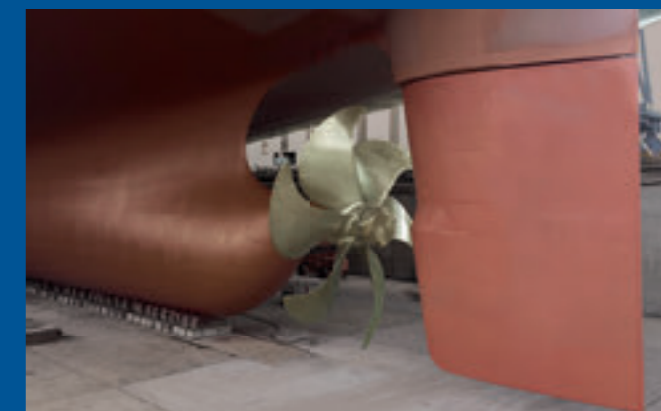
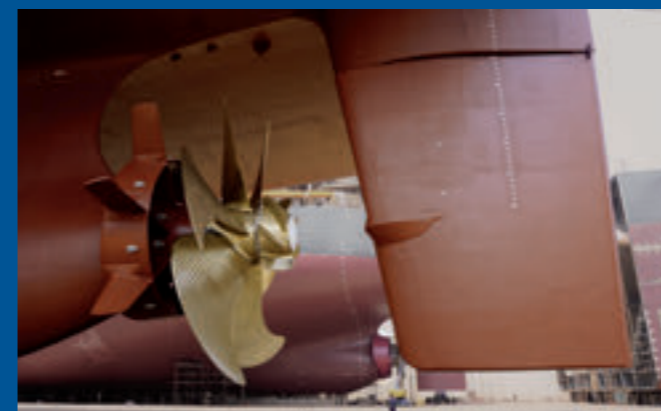



ESPECIALLY SUITED FOR:

- Shuttle tankers
- General cargo carriers/ Heavy lifters
- AHTS
- OSV/PSV
- Push boats
- Research vessels
- Fishing vessels
- Dredgers

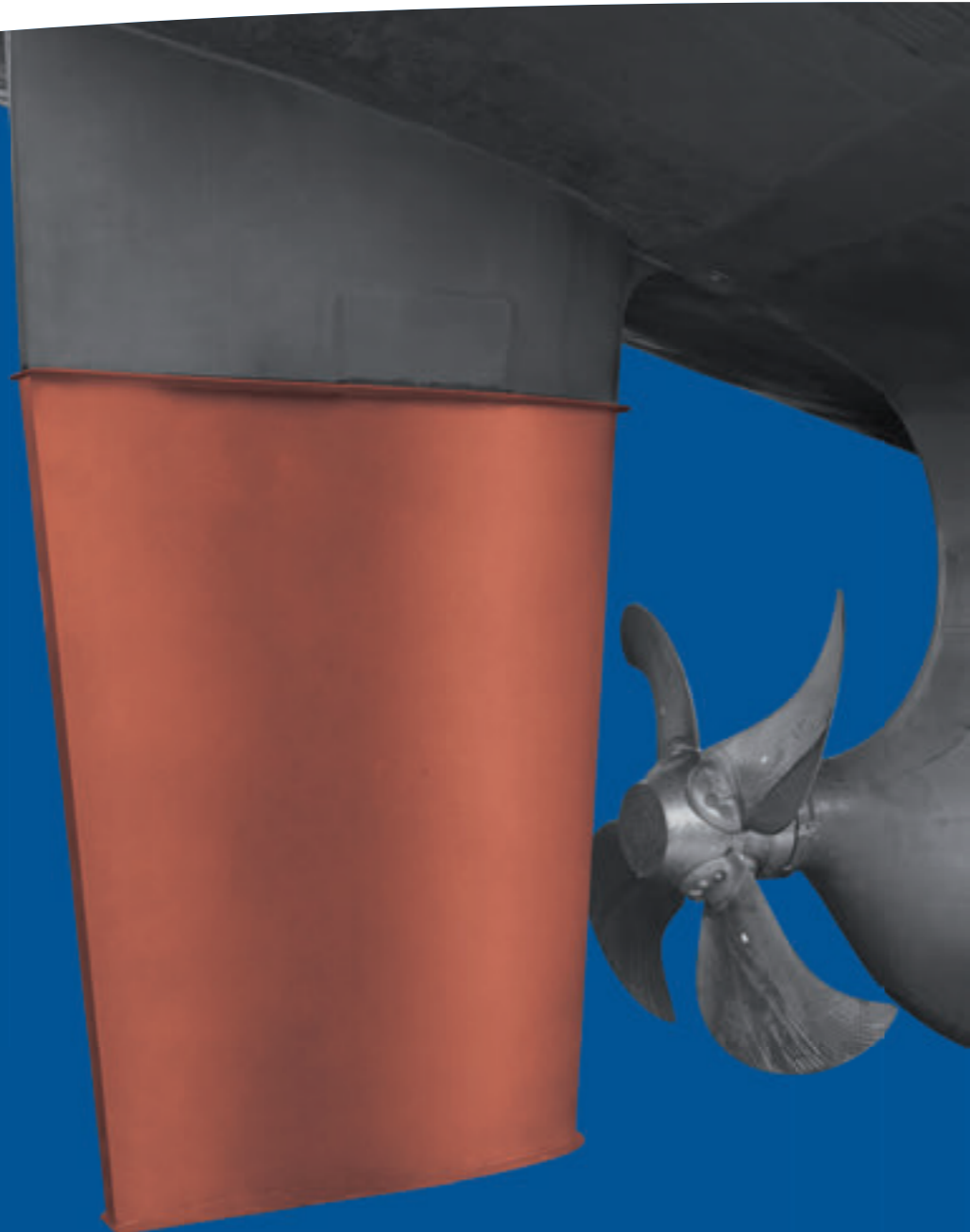

ADVANTAGES:

- Optimised profile
- Reduced weight
- No cast parts
- Highest possible lift
- Crabbing
- Improved course keeping
- DP functionality
- Reduced tug assistance
- Reduced wear and tear
- Best propeller coverage

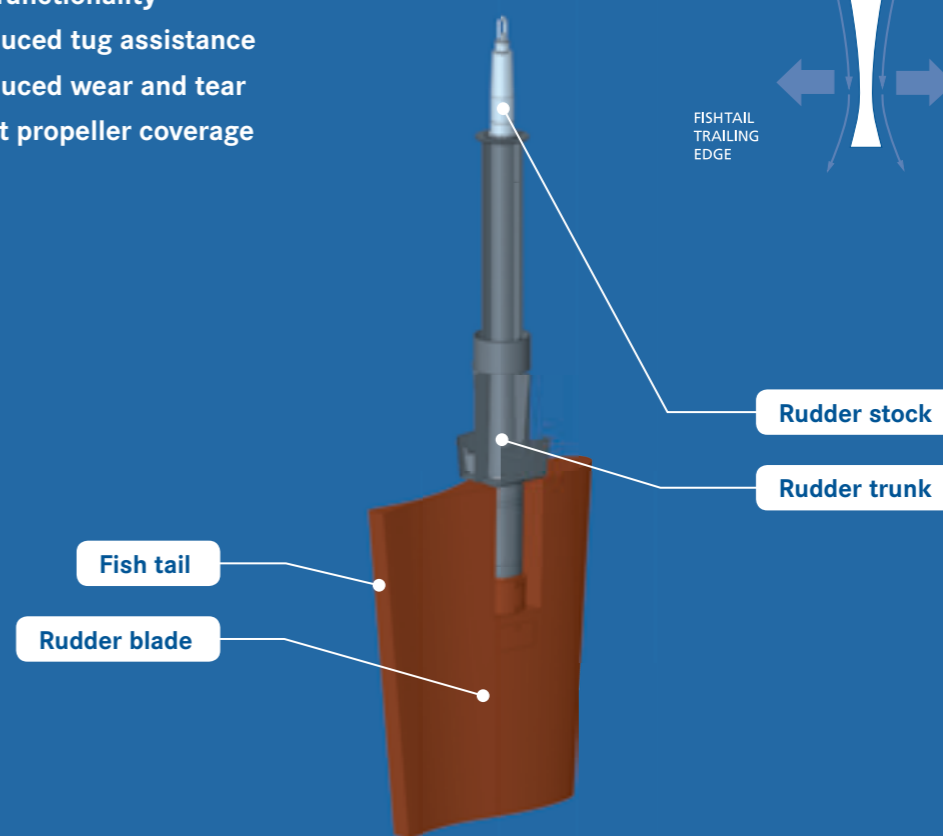
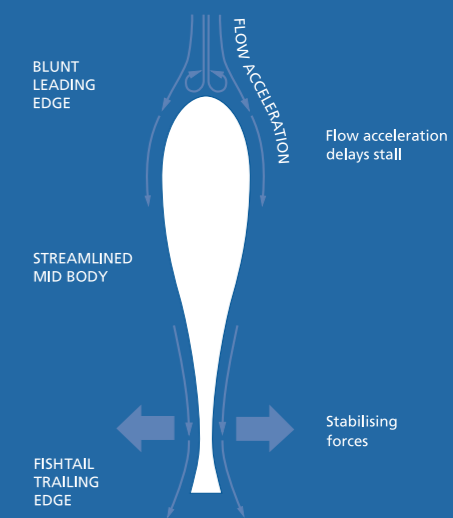

BECKER SCHILLING®



The Becker Schilling® Rudder is a high-lift rudder with a specially developed fishtail profile offering improved manoeuvrability for vessels of all sizes and types. With its special design the Becker Schilling® combines the highest lateral forces with the best course stability. The rudder forces optimised by the fishtail design guarantee improved safety and efficiency. It is available as a full spade rudder

with optional KSR (King Support Rudder). Combined with a steering gear which is suitable for higher rudder angles, the Becker Schilling® can be used for all kinds of vessels operating in DP mode. Due to its specific design, the Becker Schilling® has no wear and tear parts, which also minimises servicing and maintenance costs.





ESPECIALLY SUITED FOR:

- General cargo carriers/ Heavy lifters
- OSV/PSV
- Push boats
- Research vessels
- Fishing vessels



TWISTED TRAILING EDGE (TT)

The Becker Twisted Trailing Edge (TT) Rudder is the combination of a high-lift Schilling® profile and a plane profile. This combination assures very good manoeuvrability with the advantages of the Schilling® profile, but with lower drag at the same rudder size. The idea behind the TT Rudder was optimisation of the use and area of the fishtail trailing edge. The fishtail itself is a stagnation area and besides accelerating flow to gain additional lift forces, it produces higher drag. To reduce the drag Becker Marine Systems focuses the fishtail trailing edge on

the most effective area of the rudder referencing the rotation of the propeller slipstream. The other side of the fishtail trailing edge is plane and the drag produced by the fishtail is thus minimised. In addition, the TT Rudder improves course keeping due to the rudder's fishtail shape.

Providing high lift forces with no moveable parts, the rudder assures reduced maintenance and safe manoeuvring, also in ice. All in all, this rudder type is the best compromise of manoeuvrability and efficiency.

ADVANTAGES:

- Optimised profile
- Reduced weight
- No cast parts
- Highest possible lift
- Crabbing
- Improved course keeping
- Reduced tug assistance
- Reduced wear and tear
- Best propeller coverage

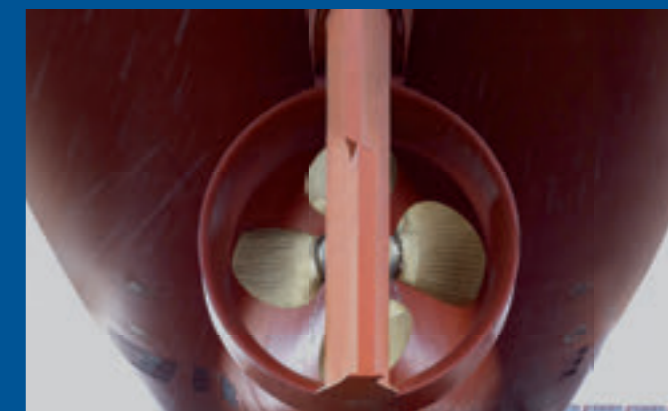
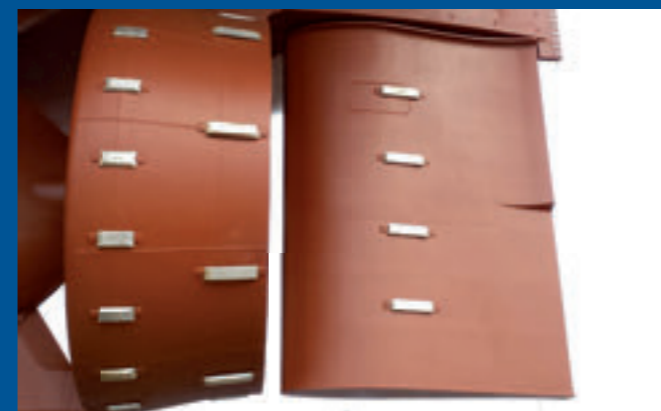
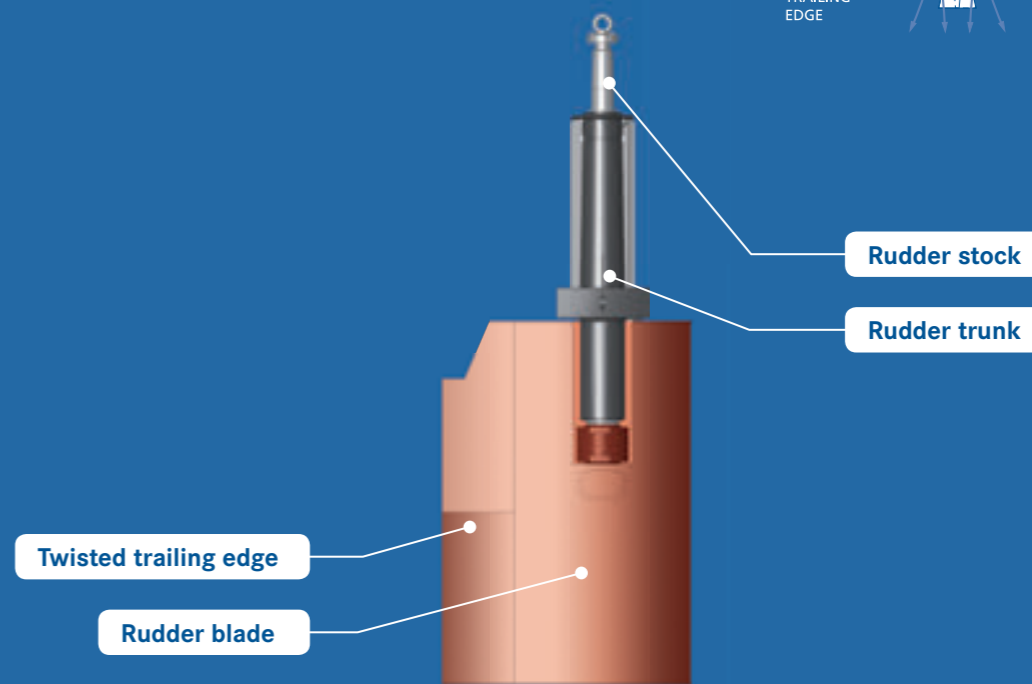
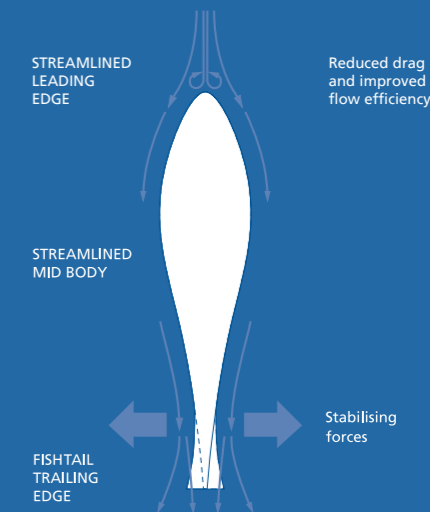



ESPECIALLY SUITED FOR:

- AHTS
- OSV/PSV
- Push boats
- Research vessels
- Fishing vessels
- Dredgers

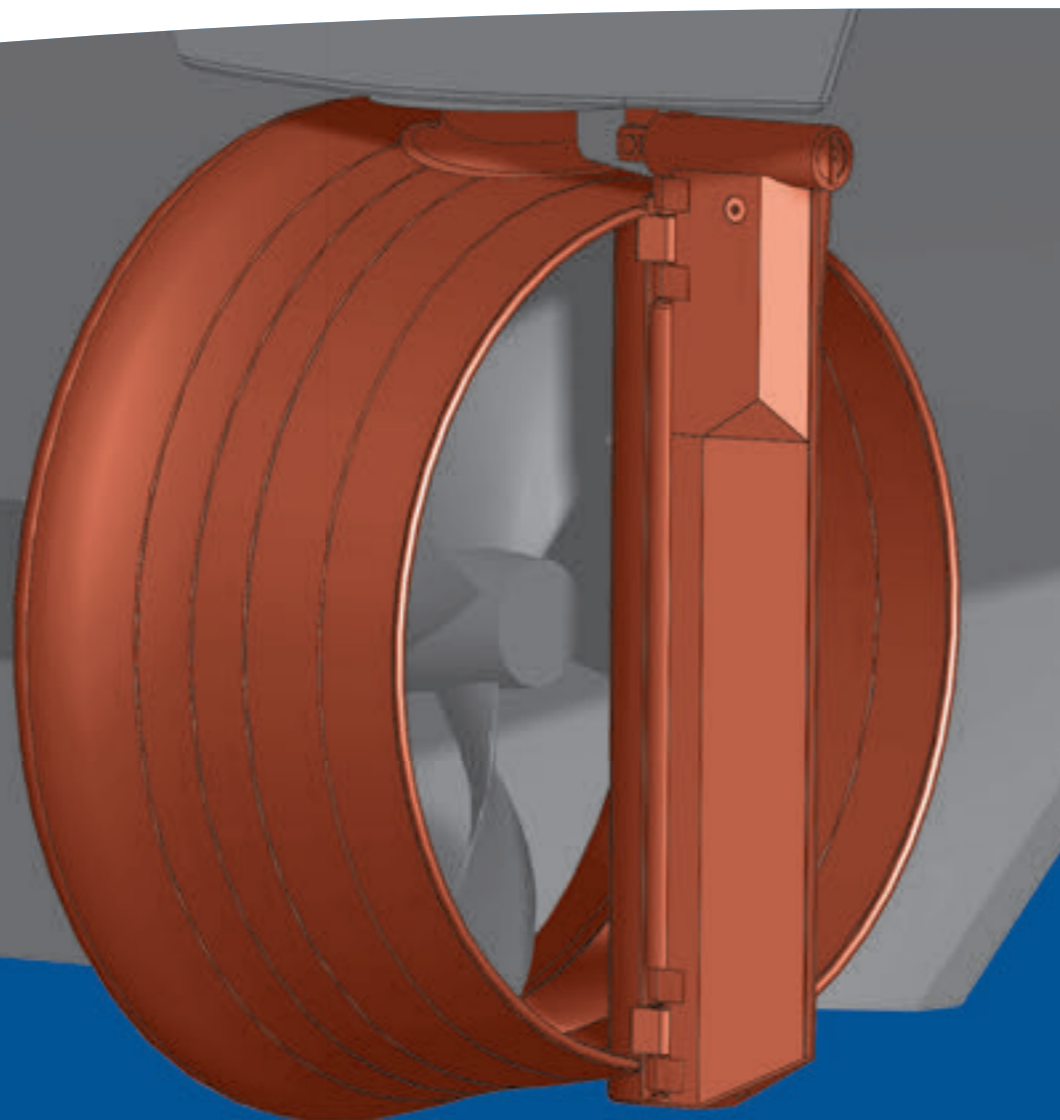

BECKER NOZZLE



Becker Marine Systems has decades of experience in designing nozzle solutions. One important step was the invention of the Kort Nozzle. Today the Becker Nozzle is offered in two basic designs:

- Becker Nozzle
- Becker Steering Nozzle

The most common type is a fixed nozzle combined with a rudder or flap rudder. This arrangement is widely used for all kinds of work boats, such as AHTS, tugboats and fishing vessels. The nozzle improves the BP performance of the vessel, which is necessary to fulfil the requirements of such vessel types.

The steerable nozzle demonstrates greatly improved manoeuvring performance by generating higher lateral forces. Less space is needed for the overall propulsion arrangement and better efficiency is achieved by placing the propeller further to the rear than the fixed nozzle. The steerable nozzle guarantees the highest pull combined with excellent manoeuvring performance.

Becker Nozzle products are fully compliant with DP regulations and can be used as a part of the DP system. Due to the excellent rudder forces at lower speeds and in BP mode, the Becker Steering Nozzle demonstrates excellent station keeping results in DP and is therefore the perfect choice for vessels operating in DP.

ADVANTAGES:

- Optimised nozzle profile
- No cast parts
- Improved manoeuvrability
- Highest possible lift
- Crabbing
- DP functionality
- Reduced wear and tear
- Increased bollard pull
- Propeller protection

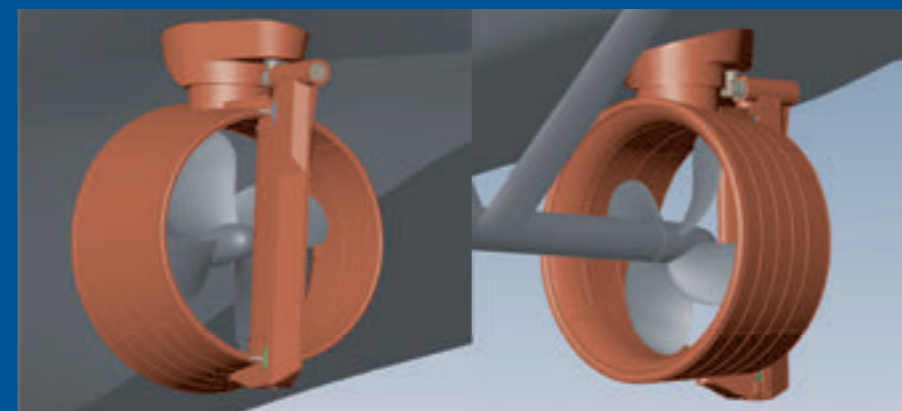
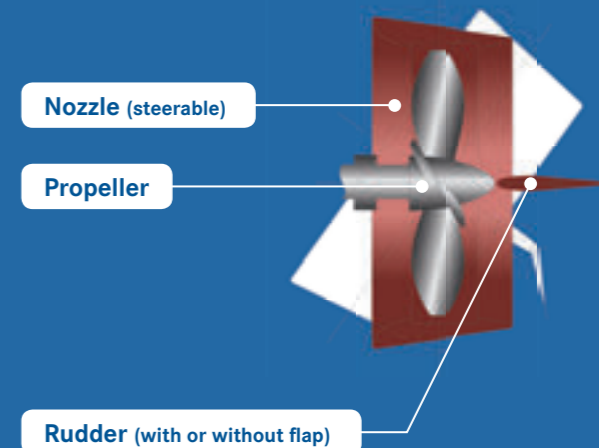
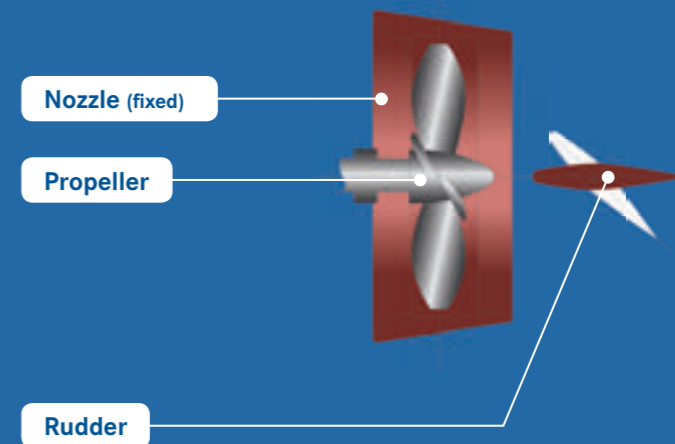



KSR – KING SUPPORT RUDDER

In order to build full spade rudders of unlimited size and slim profile thickness, Becker Marine Systems developed the KSR (King Support Rudder) bearing arrangement. With this arrangement, the rudder trunk is extended into the rudder blade so that the lower neck bearing is positioned as close as possible to the centre of force acting on the rudder. Due to the shorter lever arm, stresses and bending torques in the rudder stock and trunk are significantly reduced. The reaction forces in the neck and carrier bearings are much smaller, making it a very rigid rudder. KSR technology is the state-of-the-art solution for

rudders of unlimited size, and with only one lower bearing it provides lower maintenance than comparable semi-spade rudders. Becker Rudders do not need any castings such as a rudder horn with a gap to the blade that may cause cavitation problems and is more difficult to install in the ship's hull structure. Furthermore, a KSR rudder offers a larger active steering rudder area and can be deflected to higher rudder angles to provide highly efficient manoeuvrability. Due to reduced forces with the KSR support, the rudder profile can be designed to be more slender and thus improve efficiency.

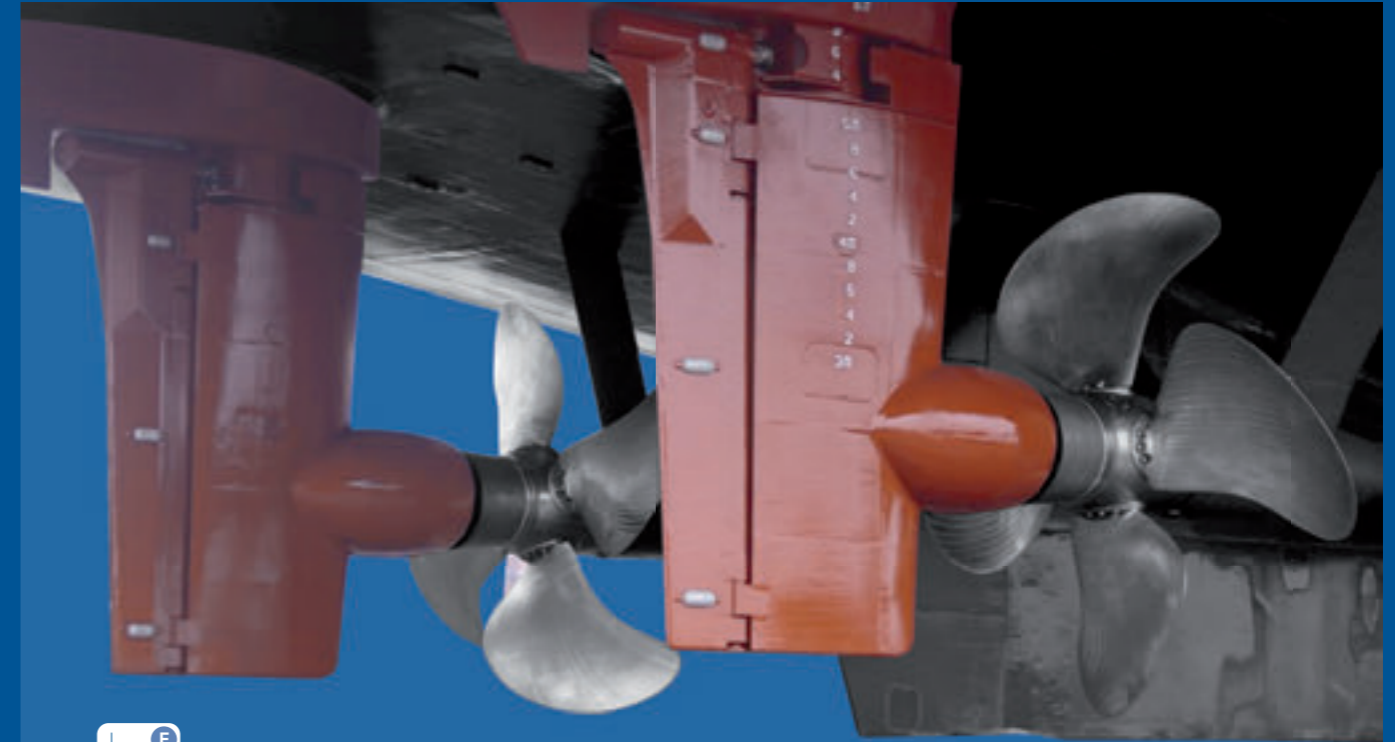

RUDDER BULB

Ship rudders are generally situated in complex, highly turbulent flow fields. This offers opportunities for significant power savings by recovering some of the associated flow energy losses through customised design of the propulsion and steering system. The Becker Rudder Bulb provides such an optimised solution.

The Becker Rudder Bulb minimises energy losses behind the propeller hub by eliminating flow separation and reducing wasteful fluid turbulence. In addition, careful design of both the bulb geometry and twisted rudder leading edge ensures optimal energy recovery from the propeller slipstream.

The streamlined bulb is positioned at the leading edge of the full spade rudder, situated aft of the propeller hub. The transition between bulb and propeller hub is bridged by a fairing cap.

The propeller hub fairing is designed to guide flow smoothly over the bulb. Thus, the hub fairing and the rudder bulb are developed as a single hydrodynamic entity from the outset.



Installation of a Becker Twist Rudder with KSR



KSR trunk for an 8,600 TEU container vessel

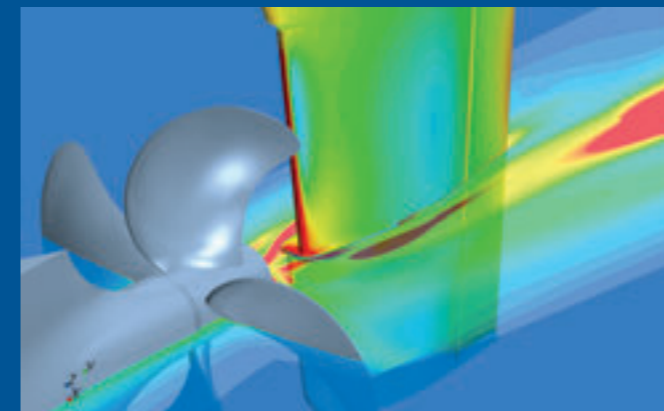

CFD simulation of energy losses in the water flow without a rudder bulb

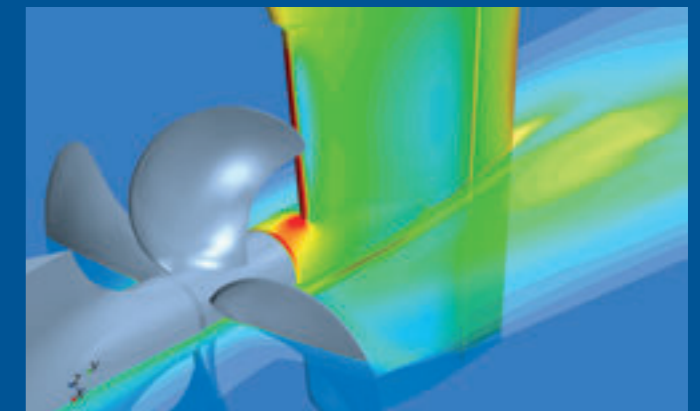

Same CFD simulation with a rudder bulb showing reduced energy losses

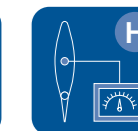

FLEXTAIL® – COMPOSITE RUDDER FLAP

Becker presents the newly developed Flextail® Rudder Flap. It features an innovative design of the improved fibre-composite flap for better flow and load handling.

Composites not only provide outstanding resistance properties at low weight, but many more capabilities in a load-optimised and functional shape design. Particularly for smaller components such as flaps, composite materials allow the manufacture of profile surfaces with better propulsion properties, improved lift generation and a slim design with lower drag. Load-adapted fibre layer arrangements help to reduce material thickness and an adjustment of flap stiffness related to rudder blade bending results in reduced wear and tear of hinge bushes. The noncorrosive property of the flap material helps to reduce the number of zinc anodes and their negative effects on propulsion efficiency.

Composite high efficiency rudder flaps are available for all kinds of Becker Flap Rudders. By specially adapting the fibre arrangement to meet the requirements of each different rudder type, Becker ensures equipment with a long service life, at the lowest operating cost – meeting our customers' demanding requirements. Servicing and maintenance costs are minimised due to the lightweight composite material.



BIMS – BECKER INTELLIGENT MONITORING SYSTEM

Until now modern navigation and positioning systems have been using rather general output signals for rudder control operation while manoeuvring, because the force generated at specific rudder angles is not available to the navigation system, resulting in less efficient manoeuvring.

The Becker Intelligent Monitoring System (BIMS) is able to directly measure rudder forces and interface them with the ship's navigation systems as well as visualise rudder lift on the bridge, thus improving manoeuvrability and allowing energy-saving autopilot operation and more efficient dynamic positioning.

- Determination of rudder lift, drag and torque
- Serial and network interfaces to navigation systems such as autopilot (AP) and dynamic positioning (DP) systems
- Fewer rudder motions during AP and DP operation
- Energy savings and emission reduction through improved efficiency
- Showing rudder force on the bridge and wings makes manoeuvring safer
- Reduced wear and costs of maintaining steering gear and rudder
- GL Type Approval

BIMS is the technology for improving safety and performance by minimising stall conditions and rudder movements.

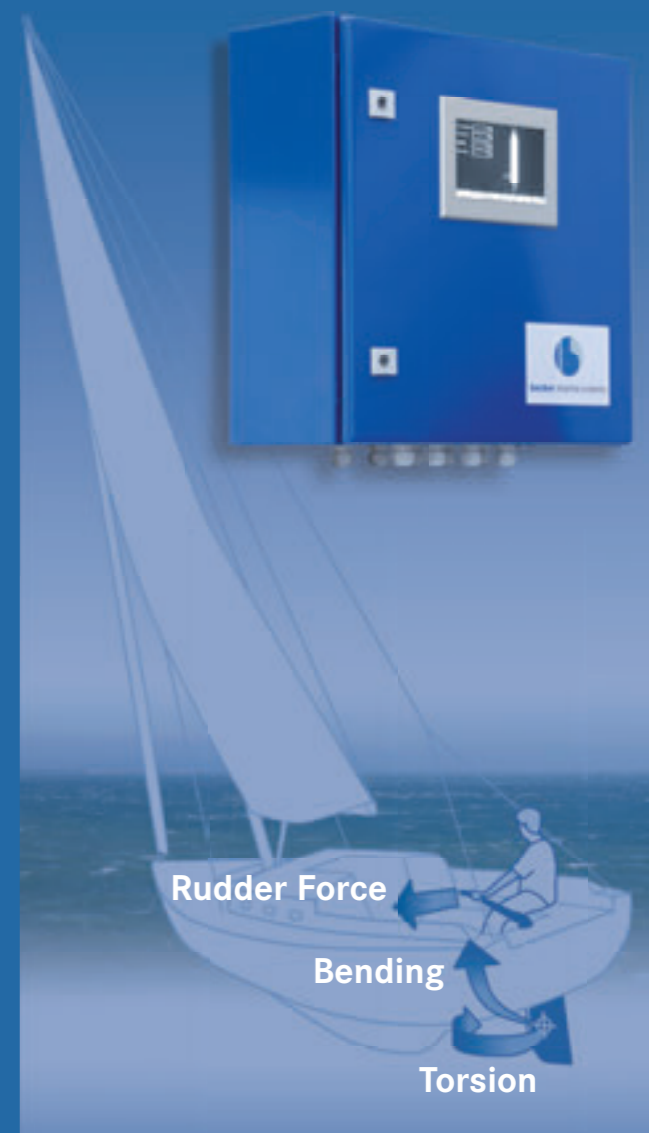

BBMS – BECKER BEARING MONITORING SYSTEM

The Becker Bearing Monitoring System (BBMS) monitors wear on the rudder neck bearing by means of four electrical wear sensors mounted in the neck bearing bush. The sensors are worn out along with the bearing bush, thus enabling precise measurement of the neck bearing clearance. The measured neck bearing clearance is transmitted via a cable connection to the processing unit mounted in the steering gear room. The processing unit incorporates a 3.5" touch panel to calibrate the system and display the monitored values as well as the wear history of the neck bearing. Via the processing unit, the neck bearing clearances and measurement values can be interfaced to any other monitoring and alarm system aboard the ship. Continuous monitoring of the neck bearing enables better planning of servicing activities and furthermore supersedes periodical neck bearing inspections performed by divers.

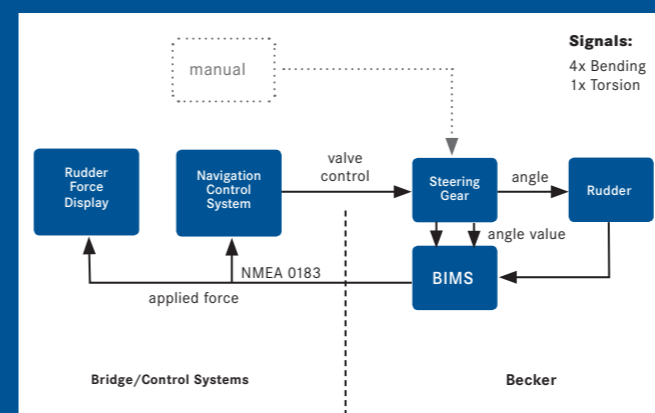

BIMS functional principle diagram



BIMS display installed on a ship's bridge



ESPECIALLY SUITED FOR:

- Tankers
- Shuttle tankers
- LNG/LPG carriers
- Bulk carriers
- General cargo carriers/ Heavy lifters
- Car carriers

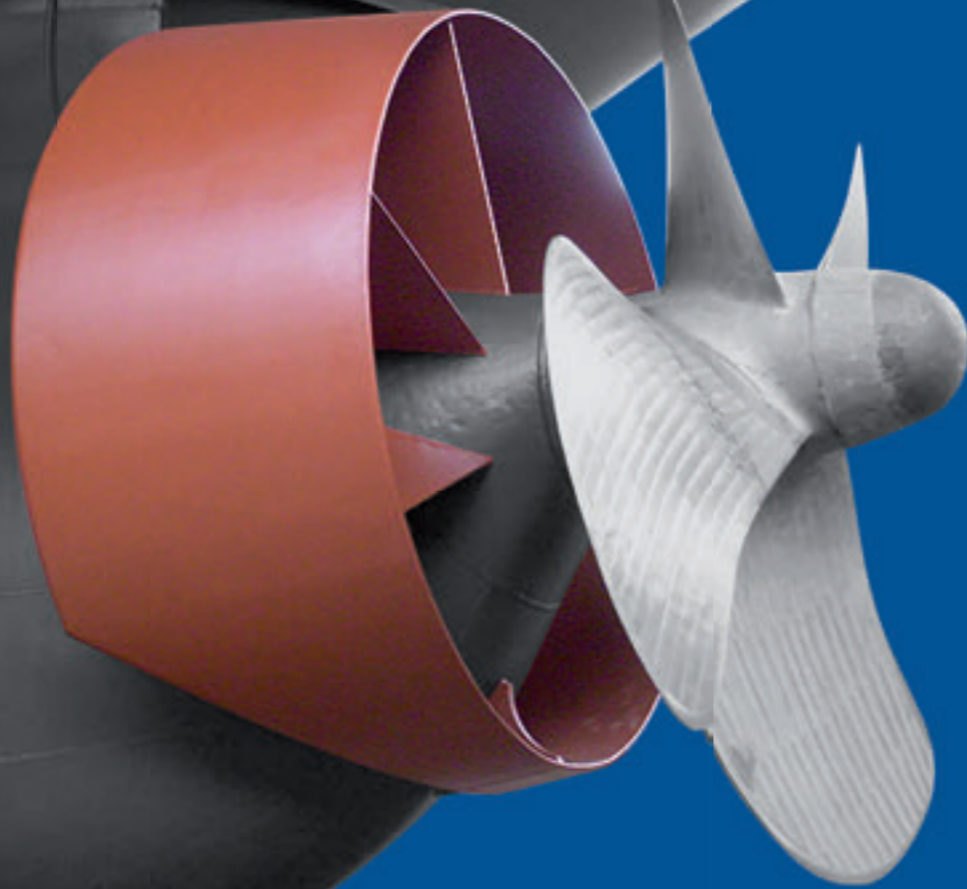

EASY INSTALLATION FOR NEWBUILDINGS AND RETROFITS

Newbuildings: Installation of the Becker Mewis Duct® can easily be performed during the block stage of the stern boss with minimal effort on the part of the shipyard and owner. The yard is able to implement the installation in the production schedule. The Becker design team installs the interfaces of the Becker Mewis Duct® and the ship according to the ship's steel structure and uses standard steel grades to build the Becker Mewis Duct®. Installation takes approx. five days.

Retrofits: Becker designed the Becker Mewis Duct® to also improve the efficiency of vessels as a retrofit option. The Becker Mewis Duct® can be installed during regular dry dockings or even intermediate dry dockings either with the propeller in place or dismantled. Becker's expertise ensures that installation is performed as quickly as possible, taking five days on average. Installation is carried out with Becker's guidance and supervision using standard welding and fitting procedures, making installation possible worldwide. The Becker Mewis Duct® design of the interfaces to the ship provides the highest strength and stiffness in accordance with classification societies.

ADVANTAGES:

- Optimised profile
- No cast parts
- Less cavitation
- Reduction of rotational losses
- Improved propulsion efficiency
- Improved course keeping
- Fuel savings
- Reduced vibration

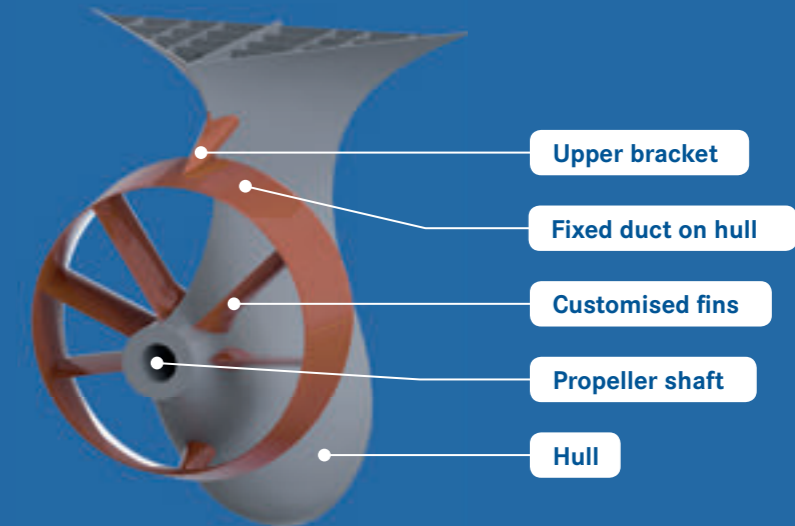

BECKER MEWIS DUCT®



The Becker Mewis Duct® is an energy-saving device developed for full-form slower ships enabling either a significant fuel savings at a given speed or, alternatively, the vessel to travel faster at a given power level.

The Becker Mewis Duct® consists of two strong fixed elements mounted on the vessel: a duct positioned in front of the propeller along with an integrated fin system. The duct straightens and accelerates the hull wake into the propeller and also produces a net forward thrust. The fin system provides a pre-swirl to the ship wake which reduces losses in the propeller slipstream, resulting in an increase in propeller thrust at a given propulsive power. Both effects

contribute to one another. The power savings attainable from the Becker Mewis Duct® are strongly dependent on propeller thrust loading, from 3 to 8% depending on individual hull/propeller interaction. The power savings are virtually independent of ship speed. The Becker Mewis Duct® is ideally suited to both new-build and retrofit applications (e.g. tankers, bulkers and MPCs).

- Energy savings up to 8%
- Low SO_x and CO₂ emissions
- No moving parts



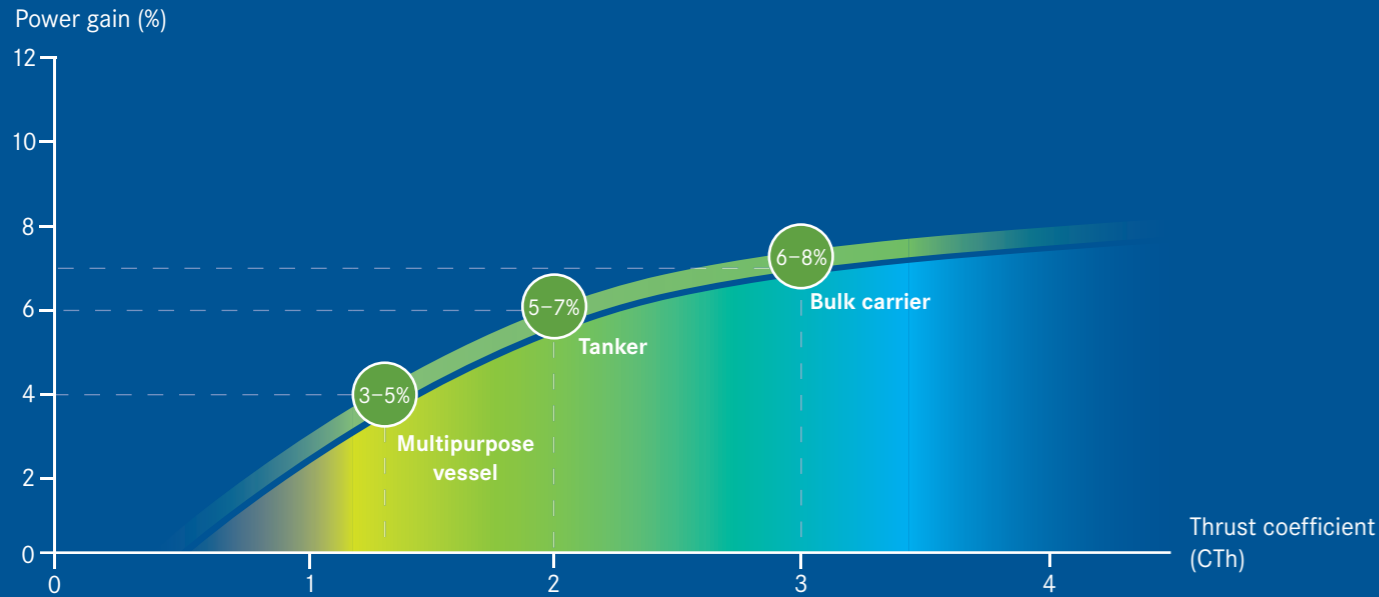

Possible savings of the Becker Mewis Duct® and the dependence between the ship's size and power savings achieved

WAKEFIELD EQUALISATION

The Becker Mewis Duct® straightens and accelerates the hull's wake into the propeller and also produces net forward thrust.

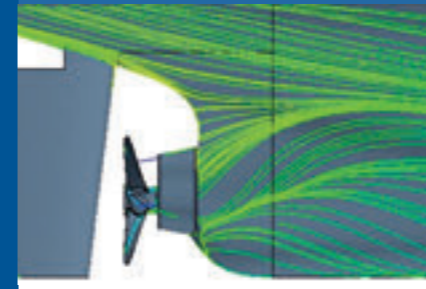

REDUCTION OF PROPELLER HUB VORTEX

An improved slipstream behind the duct significantly reduces the hub vortex with a corresponding reduction in thrust, leading to improved thrust and inflow to the rudder.

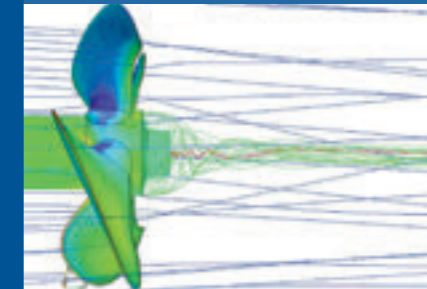

CONTRA-ROTATING SWIRL

Due to individually placed fins a pre-swirl in counter direction of the propeller operation is generated, recovering the rotational energy from the slipstream.

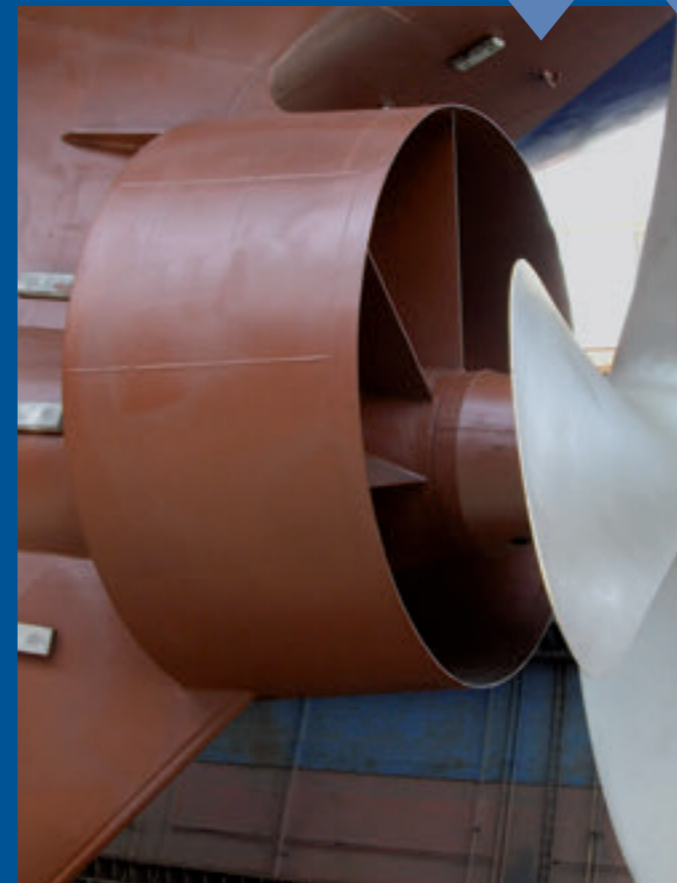
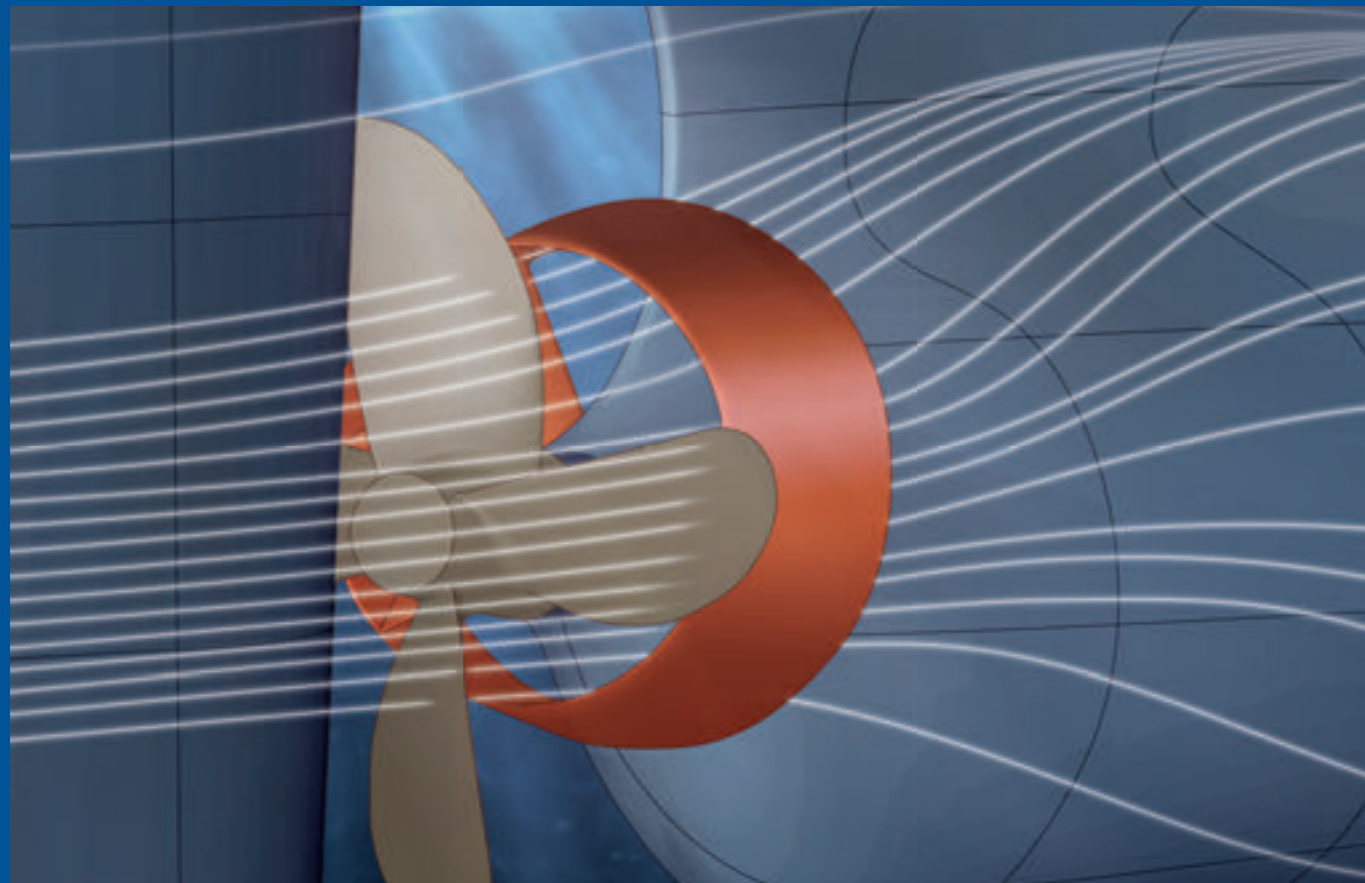
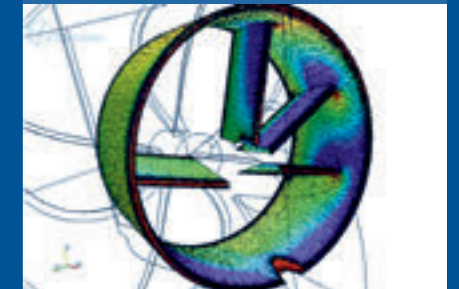

ALL IN ONE – BECKER MEWIS DUCT®

The Becker Mewis Duct® combines all three of the principles above in a non-linear interaction:

The Becker Mewis Duct® harmonises and stabilises flow and generates a pre-swirl to reduce the rotational losses in the propeller slipstream. The integrated fins have a stator effect by generating a pre-swirl counter to the direction of propeller operation. This generates more thrust. The fins are asymmetrically profiled and arranged to generate a perfectly homogenous flow distribution.

The combination of the Becker Mewis Duct® with a Becker Rudder dramatically increases the efficiency of the system by means of wakefield optimisation and lower rudder resistance with improved manoeuvring performance.



ESPECIALLY SUITED FOR:

- Container feeders
- Container liners
- LNG/LPG carriers
- Car carriers
- ConRo/RoRo
- Navy ships

ADVANTAGES:

- Optimised profile
- No cast parts
- Less cavitation
- Reduction of rotational losses
- Improved propulsion efficiency
- Improved course keeping
- Fuel saving
- Reduced vibration

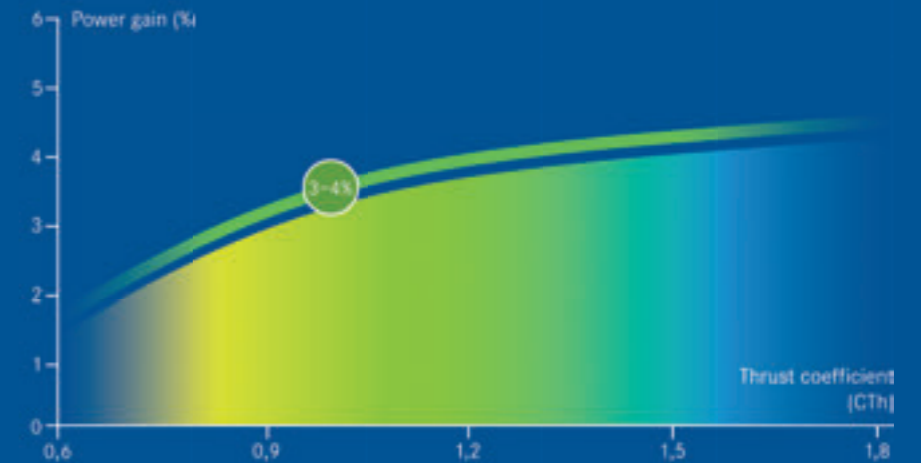

Diagram of power gained by Becker Mewis Duct® Twisted

THE DEVELOPMENT FROM DUCT TO FIN

Becker Marine Systems has focused on energy savings and with the Becker Mewis Duct® provides one of the most efficient energy-saving devices for the maritime market. On average, power savings of over 6% were able to be achieved for large and slow vessels such as tankers and bulkers.

Savings from the Becker Mewis Duct® are reduced at speeds above approx. 20 knots. Becker Marine Systems has introduced the Becker Mewis Duct® Twisted for faster hull optimised ships with speeds above 18 knots. Like the Becker Mewis Duct®, the Becker Mewis Duct® Twisted has no moveable parts, is also installed in front of the propeller and generates a pre-swirl. The system thus provides fast ships with tangible energy savings.

The nozzle ring is significantly smaller than the one on the Becker Mewis Duct® and has a special, flat profile with much lower drag. The fins familiar from the Becker Mewis Duct® on the inside of the nozzle ring extend outwards beyond the nozzle. To prevent the formation of a swirl with cavitation at the ends of the fins Becker has developed special end caps for the fins. The small nozzle ring generates thrust, provides stability to the fins and reduces vibrations.



Computational Fluid Dynamics tests, model tests and full scale operation have demonstrated fuel savings averaging 3% for container ships. Even better results can be obtained with the combination of a Becker Mewis Duct® Twisted and Becker Twist Rudder.

Each Becker Mewis Duct® Twisted is individually designed according to hull geometry, propeller design and engine data. The design takes into account the newest strength, fatigue and vibration requirements from classification societies.

BECKER MEWIS DUCT® TWISTED

Becker Marine Systems has responded to the heavy demand of shipping companies for an energy-saving device for faster vessels. After two years of research and based on seven years of operational experience with the Becker Mewis Duct®, a new energy-saving device for container ships and other types of fast vessels with bulbous stern has entered the market – the Becker Mewis Duct® Twisted. In combination with a new propeller, the Becker Mewis Duct® Twisted can be part of a complete hydrodynamic performance package. With an existing propeller design, the Becker Mewis Duct® Twisted is designed in accordance with the propeller design.

- Average energy savings of 3%
- Reduction of NO_x and CO₂ emissions
- Structural guarantee of many years
- Guarantee of power reduction as verified by model test: "Money saved or money back"
- Suitable for newbuildings and retrofits
- No moving parts, no maintenance required
- Fast installation



ESPECIALLY SUITED FOR:

- Container feeders
- Container liners
- Tankers
- Shuttle tankers
- LNG/LPG carriers
- Bulk carriers
- General cargo carriers/
Heavy lifters
- Car carriers
- ConRo/RoRo
- Ferries
- Navy ships



ADVANTAGES:

- Optimised rudder profile
- Reduced weight
- No cast parts
- Less cavitation
- Reduction of rotational losses
- Improved propulsion efficiency
- Minimised drag
- Improved course keeping
- Fuel savings
- Reduced wear and tear
- Best propeller coverage
- Reduced vibration

COMBINED ENERGY SAVINGS

With the maximum energy savings brought about by the Becker Rudder and a Becker Mewis Duct® or Becker Mewis Duct® Twisted, the BPP is applicable to almost every hull form as well as virtually every propeller.

With the BPP clients such as shipyards, ship designers and ship owners/managers have the opportunity to apply a tailor-made and advanced energy-saving solution in order to achieve significant efficiency gains for a given hull form and given propeller designs and by doing so close a gap in required ship speed or achieve a specific required power savings.

BECKER PERFORMANCE PACKAGE (BPP)

The combination of a Becker Rudder and Becker Mewis Duct® or Becker Mewis Duct® Twisted enables maximum possible energy savings in front of and behind the propeller. Both products are available from a single company and are thus perfectly harmonised via Computational Fluid Dynamics (CFD) calculations for optimised manoeuvring and maximum energy savings.

The total performance improvement is based on two parts, the active part related to the improvement of flow towards

the propeller, the reduction of losses, the pre-swirl and the passive part for minimising drag and improving course stability.

Becker Marine Systems constantly reviews the best combinations of a Becker Mewis Duct® or Becker Mewis Duct® Twisted with a rudder system such as the Becker Flap, Becker Twist or Becker Schilling® Rudder, resulting in the best combination of manoeuvrability and efficiency.

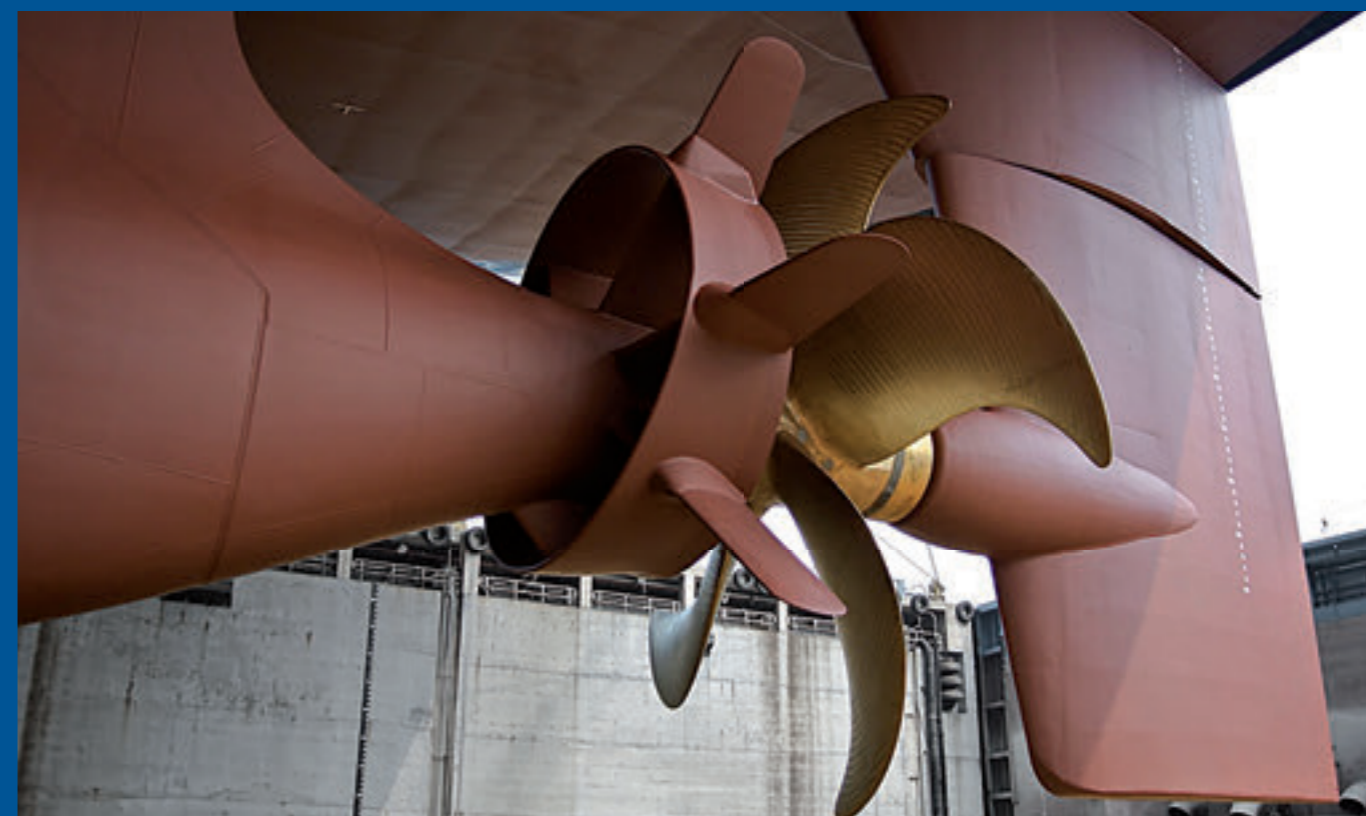

Becker Performance Package, consisting of a Becker Mewis Duct® Twisted and a Becker Twist Rudder with bulb



LNG HYBRID CONCEPTS

Becker Marine Systems has demonstrated its green policy with the development of solutions to improve fuel consumption and safety during vessel operation. With its liquefied natural gas (LNG) concepts, Becker Marine Systems is proving once again the company's innovative spirit on behalf of our environment.

Becker's LNG Hybrid Barge generates energy for cruise ships lying at port. Compared to the current method of producing energy using on-board diesel engines, power supplied by the LNG Hybrid Barge will lead to a dramatic reduction of harmful CO₂, NO_x, SO_x and particle emissions during layovers at port.

The LNG Hybrid Barge was developed with a cruise line company to guarantee cold ironing for the cruise liners during the stay at port. Becker Marine Systems has managed to complete the project from basic design to the

commissioning phase. Since spring 2015 the barge has been in operation at the Port of Hamburg.

Another LNG-powered concept, the LNG PowerPac[®], has been developed in order to supply clean energy to other ships at port such as containers, bulkers or tanker vessels. The LNG PowerPac[®] enables cold ironing for vessels during port operation. Furthermore, it can supply reefer containers with the energy needed. The system is containerised and simply stored on board during the vessel's layover.

Becker Marine Systems has initiated the development of LNG and hybrid concepts for ferries. This is a result of the experience gained with the LNG Hybrid Barge and the PowerPac[®]. Becker's LNG team has acquired expertise, particularly in the integration and combination of LNG fuel storage, LNG gas supply and power generation.



LNG-powered and container-based energy concept



elblinien ferry concept with LNG Hybrid drive



CONVERSION – UPGRADING YOUR VESSEL

More and more owners and yards are contacting our Service Team about converting original configurations to Becker Rudders. The manoeuvring and efficiency performance of the original configuration often falls below expectations or has shown poor results during vessel operation. One of the major problems causing damage to rudder blades is cavitation. As the inventor of the twisted rudder, Becker Marine Systems has developed individual solutions to avoid rudder induced cavitation and reduce cavitation caused by propeller tip and hub vortices.

When it comes to manoeuvrability, reliability, efficiency and cavitation avoidance, Becker combines experience with new technologies such as CFD to develop the optimal solution for operators. We are the top choice to provide the perfect rudder replacement. Together with the customer, the Becker Service Team will analyse the individual requirements. Becker's design and CFD team is skilled in providing the best solution to simplify installation and fulfil the customer's expectations in terms of manoeuvrability and efficiency.



The old rudder on a vehicles carrier



Installation of an optimised hub cap designed by Becker



Complete refit with hub cap and a Becker Twist Rudder with bulb

SERVICE & REPAIR – WORLDWIDE, 24/7

Becker Marine Systems is the world market leader in state-of-the-art rudder, duct and nozzle systems. Our technical team combines their efforts and experience in designing reliable, robust and well-performing manoeuvring systems.

With thousands of systems installed, and many of them already in service for decades, it is vital to us to provide you with the best possible after-sales service. Whatever the query or problem you may have regarding your vessel, our Service Team of experienced supervisors and technical experts are there for both planned maintenance and emergency repairs of Becker or non-Becker products. With six of our own offices equipped with spares and service technicians and more than 20 agents, Becker Marine Systems is represented all over the world. And of course the Becker Service Team is available worldwide on a 24/7 basis.

SERVICE CONTACT

Tel. +49-40-2 41 99-1410 (office hours)
 Tel. +49-173-922 93 11 (24/7)
service@becker-marine-systems.com

BECKER AND NON-BECKER SPARE PARTS

The relationship with our clients does not end after delivery. After sales services have always been important to us. In order to guarantee the best service, we ensure delivery of original spare parts – with the shortest of delivery times.

Many standard Becker spare parts are available in stock. Thanks to our network of production facilities in Europe and Asia, tailor-made spares can also be quickly delivered to locations across the world. This service is not restricted to Becker products: our service team is looking forward to your enquiry about spare parts for non-Becker rudders.



Delivering Becker spare parts



MANOEUVRING TRAINING

Our manoeuvring training course shows your captain how to get the best performance out of Becker's manoeuvring systems. We illustrate the manoeuvring advantages over standard rudders and enable your captain to bid farewell to tugs.

The course consists of emergency manoeuvres, berthing, unberthing, crabbing and docking.

We also offer our manoeuvring training course as a simulation. Your captain's knowledge can be improved in a safe environment. Various ship types (e.g. twin screw ferries, tankers, container vessels, etc.) are already available as digital models and can be modified to simulate the performance of a Becker rudder based on our CFD calculations. It is of course also possible to generate a simulated vessel based on your own data.

The training course offers a remarkable opportunity to compare the performance of different rudders on the same ship with unchanged conditions and is available for groups, offering great benefits at low cost. Our training staff has nautical education and experience in the operation of many different ship types.



REMOTE UNDERWATER DIGITAL IMAGING (RUDI) CAMERA

The RUDI camera system is a digital device our Sales and Service team uses to capture underwater pictures and videos of the ship's propulsion system when in action under any sea conditions.

The RUDI system is a very effective and useful tool for inspecting and investigating propulsion systems during operation. Unlike normal maintenance methods, RUDI enables the monitoring and archiving of all underwater events in real time. This SD or HD video material makes it possible to

analyse the propulsion system, help solve problems such as vibrations or cavitation or prepare the next dry docking in terms of the required labour input and the estimated time at the shipyard. RUDI is not a fixed installation. It is a mountable device which is removed after operation. Our customers face no time losses because installation and removal of the device takes place during loading and unloading at port.

On request we would be happy to write up a final report combined with hydrodynamic analysis.



Becker Marine Systems GmbH & Co. KG

Head Office
 Blohmstr. 23
 21079 Hamburg, Germany
 Tel. +49-40-2 41 99-0
 Fax +49-40-280 18 99

www.becker-marine-systems.com
info@becker-marine-systems.com

Service Contact

Tel. +49-40-2 41 99-1410 (office hours)
 Tel. +49-173-922 93 11 (24/7)
service@becker-marine-systems.com

Authorised Distributor



t: +44 1264 860186
 e: spares@simplexturbulo.com

STC is a member of 

Becker Marine Systems Asia Pte. Ltd.

25 International Business Park
 No. 04-106 German Centre, Singapore 609916, Singapore
 Tel. +65-656-281 81, Fax +65-656-281 82

Becker Marine Systems China Ltd.

Room 2702-2703, Jiangnan Shipyard Building
 600 Luban Road, Shanghai 200023, P.R. China
 Tel. +86-21-53 01 99 11-0, Fax +86-21-53 01 53 39

Becker Marine Systems JiangSu Co. Ltd.

No. 709 ChangJiang Road, Industry Park Runzhou District
 Zhenjiang 212005, P.R. China
 Tel. +86-511-80 86 26 26, Fax +86-511-80 86 26 00

Becker Marine Systems Korea Ltd.

KNN Tower #909, Centum seo-ro 30
 Haeundae-gu, Busan, 48058, Republic of Korea
 Tel. +82-51-664-6760, Fax +82-51-664-6766

Becker Marine Systems Norway AS

Office address: Askheim 1C, 2022 Gjerdrum, Norway
 Postal address: P.O. Box 4, 2024 Gjerdrum, Norway
 Tel. +47-63-93 91-91, Fax +47-63-99 09 04

Becker Marine Systems USA, Inc.

105 Magellan Circle, Unit B
 Webster, TX 77598, USA
 Tel. +1-844-267-8721, Fax +1-281-332-4511

Schilling® Rudders are available in Japan only under the designation Becker SHARC Fishtail Rudder.



Manoeuvring Systems

Rudders
 Nozzles
 Rudder Control & Monitoring



Energy-Saving Devices

Becker Mewis Duct®
 Becker Mewis Duct® Twisted



LNG Hybrid Concepts

LNG Hybrid Barge
 LNG PowerPac®
 LNG Hybrid Ferries